

NPN Silicon RF Transistor

- For high gain low noise amplifiers
- For oscillators up to 10 GHz
- Noise figure $F = 1.05$ dB at 1.8 GHz
outstanding $G_{ms} = 20$ dB at 1.8 GHz
- Transition frequency $f_T = 25$ GHz
- Gold metalization for high reliability
- **SIEGET® 25 - Line**
Siemens Grounded Emitter Transistor
25 GHz f_T - Line

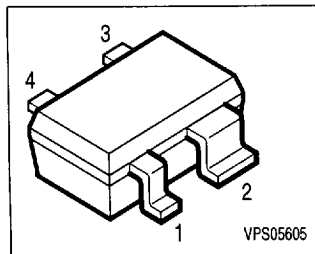

ESD: Electrostatic discharge sensitive device, observe handling precaution!

Type	Marking	Ordering Code	Pin Configuration				Package
BFP 420	AMs	Q62702-F1591	1 = B	2 = E	3 = C	4 = E	SOT-343

Maximum Ratings

Parameter	Symbol	Value	Unit
Collector-emitter voltage	V_{CEO}	4.5	V
Collector-base voltage	V_{CBO}	15	
Emitter-base voltage	V_{EBO}	1.5	
Collector current	I_C	35	mA
Base current	I_B	3	
Total power dissipation, $T_S \leq 107^\circ\text{C}$	P_{tot}	160	mW
Junction temperature	T_j	150	$^\circ\text{C}$
Ambient temperature	T_A	-65 ... +150	
Storage temperature	T_{stg}	-65 ... +150	
Thermal Resistance			
Junction - soldering point ¹⁾	R_{thJS}	≤ 270	K/W

1) T_S is measured on the collector lead at the soldering point to the pcb

Electrical Characteristics at $T_A = 25^\circ\text{C}$, unless otherwise specified.

Parameter	Symbol	Values			Unit
		min.	typ.	max.	
DC characteristics					
Collector-emitter breakdown voltage $I_C = 1 \text{ mA}, I_B = 0$	$V_{(BR)CEO}$	4.5	5	6.5	V
Collector-base cutoff current $V_{CB} = 5 \text{ V}, I_E = 0$	I_{CBO}	-	-	200	nA
Emitter-base cutoff current $V_{EB} = 1.5 \text{ V}, I_C = 0$	I_{EBO}	-	-	35	μA
DC current gain $I_C = 20 \text{ mA}, V_{CE} = 4 \text{ V}$	h_{FE}	50	80	150	-
AC characteristics					
Transition frequency $I_C = 30 \text{ mA}, V_{CE} = 3 \text{ V}, f = 2 \text{ GHz}$	f_T	20	25	-	GHz
Collector-base capacitance $V_{CB} = 2 \text{ V}, f = 1 \text{ MHz}$	C_{cb}	-	0.15	0.24	pF
Collector-emitter capacitance $V_{CE} = 2 \text{ V}, f = 1 \text{ MHz}$	C_{ce}	-	0.41	-	
Emitter-base capacitance $V_{EB} = 0.5 \text{ V}, f = 1 \text{ MHz}$	C_{eb}	-	0.55	-	
Noise figure $I_C = 5 \text{ mA}, V_{CE} = 2 \text{ V}, Z_S = Z_{Sopt}, f = 1.8 \text{ GHz}$	F	-	1.05	1.4	dB
Power gain ¹⁾ $I_C = 20 \text{ mA}, V_{CE} = 2 \text{ V}, Z_S = Z_{Sopt}, Z_L = Z_{Lopt}, f = 1.8 \text{ GHz}$	G_{ms}	-	20	-	
Insertion power gain $I_C = 20 \text{ mA}, V_{CE} = 2 \text{ V}, f = 1.8 \text{ GHz}, Z_S = Z_L = 50\Omega$	$ S_{21} ^2$	14	17	-	
Third order intercept point $I_C = 20 \text{ mA}, V_{CE} = 2 \text{ V}, Z_S = Z_{Sopt}, Z_L = Z_{Lopt}, f = 1.8 \text{ GHz}$	IP_3	-	22	-	dBm
1dB Compression point $I_C = 20 \text{ mA}, V_{CE} = 2 \text{ V}, f = 1.8 \text{ GHz}, Z_S = Z_{Sopt}, Z_L = Z_{Lopt}$	P_{-1dB}	-	12	-	

1) $G_{ms} = |S_{21}| / |S_{12}|$

■ 8235605 0121994 091 ■

Common Emitter S-Parameters

f	S ₁₁		S ₂₁		S ₁₂		S ₂₂	
	MAG	ANG	MAG	ANG	MAG	ANG	MAG	ANG
V _{CE} = 2V, I _C = 20mA								
0.01	0.543	-2.5	36.88	178.1	0.0009	95.8	0.96	-0.6
0.1	0.538	-25.1	35.4	164.4	0.0075	79.3	0.946	-12.3
0.5	0.448	-99.3	22.87	120.8	0.0272	58.7	0.633	-45.2
1	0.417	-143.6	13.46	96.3	0.0398	55.2	0.399	-60.3
2	0.437	176.2	6.93	71.5	0.062	53.5	0.227	-77.1
3	0.472	152.8	4.59	54.4	0.09	48.6	0.134	-96.7
4	0.53	133.3	3.339	38.9	0.115	40.5	0.109	-144.5
6	0.617	109.1	2.15	12.9	0.156	25.3	0.136	144.1
8	0.73	82.5	1.46	-16.8	0.172	5.4	0.229	101.3
9	0.788	72.6	1.2	-30.4	0.174	-5	0.319	86.1
10	0.82	67	1	-39.5	0.172	-11.3	0.405	78.6

Common Emitter Noise Parameters

f	F _{min} ¹⁾	G _a ¹⁾	Γ _{opt}		R _N	r _n	F _{50Ω} ²⁾	S ₂₁ ² ²⁾
GHz	dB	dB	MAG	ANG	Ω	-	dB	dB
V _{CE} = 2V, I _C = 5mA								
0.9	0.9	20.5	0.19	30	8.7	0.17	1.02	20.3
1.8	1.05	15.2	0.11	64	7.5	0.15	1.11	15.8
2.4	1.25	13	0.11	116	7	0.14	1.32	13.5
3	1.38	12.1	0.19	165	6.5	0.13	1.48	11.6
4	1.55	10.3	0.28	-155	7	0.14	1.83	9.1
5	1.75	8.6	0.37	-130	10	0.2	2.2	7
6	2.2	6.4	0.44	-117	15	0.3	3.3	5.3

1) Input matched for minimum noise figure, output for maximum gain

2) Z_S = Z_L = 50Ω

For more and detailed S- and Noise-parameters please contact your local Siemens distributor or sales office to obtain a Siemens Application Notes CD-ROM or see Internet: <http://www.siemens.de/Semiconductor/products/35/35.htm>

SPICE Parameters (Gummel-Poon Model, Berkeley-SPICE 2G.6 Syntax) :

Transistor Chip Data

IS =	0.20045	aA	BF =	72.534	-	NF =	1.2432	-
VAF =	28.383	V	IKF =	0.48731	A	ISE =	19.049	pA
NE =	2.0518	-	BR =	7.8287	-	NR =	1.3325	-
VAR =	19.705	V	IKR =	0.69141	A	ISC =	0.019237	A
NC =	1.1724	-	RB =	3.4849	Ω	IRB =	0.72983	mA
RBM =	8.5757	Ω	RE =	0.31111		RC =	0.10105	Ω
CJE =	1.8063	fF	VJE =	0.8051	V	MJE =	0.46576	-
TF =	6.7661	ps	XTF =	0.42199	-	VTF =	0.23794	V
ITF =	1	mA	PTF =	0	deg	CJC =	234.53	fF
VJC =	0.81969	V	MJC =	0.30232	-	XCJC =	0.3	-
TR =	2.3249	ns	CJS =	0	F	VJS =	0.75	V
MJS =	0	-	XTB =	0	-	EG =	1.11	eV
XTI =	3	-	FC =	0.73234	-	TNOM	300	K

C'-E'-Diode Data (Berkeley-SPICE 2G.6 Syntax) :

IS =	3.5	fA	N =	1.02	-	RS =	10	Ω
------	-----	----	-----	------	---	------	----	----------

All parameters are ready to use, no scaling is necessary

Package Equivalent Circuit:

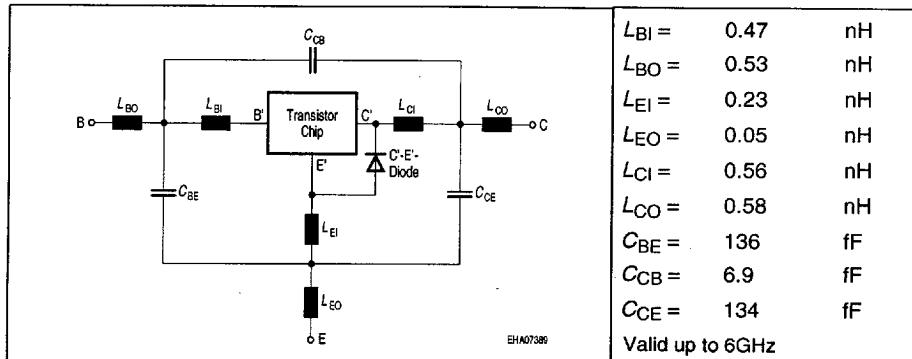

The SOT-343 package has two emitter leads. To avoid high complexity of the package equivalent circuit, both leads are combined in one electrical connection.

Extracted on behalf of SIEMENS Small Signal Semiconductors by:

Institut für Mobil-und Satellitentechnik (IMST)

© 1996 SIEMENS AG

For examples and ready to use parameters please contact your local Siemens distributor or sales office to obtain a Siemens CD-ROM or see Internet: <http://www.siemens.de/Semiconductor/products/35/35.htm>

For non-linear simulation:

- Use transistor chip parameters in Berkeley SPICE 2G.6 syntax for all simulators.
- If you need simulation of thereverse characteristics, add the diode with the C'-E'- diode data between collector and emitter.
- Simulation of package is not necessary for frequencities < 100MHz.
For higher frequencies add the wiring of package equivalent circuit around the non-linear transistor and diode model.

Note:

- This transistor is constructed in a common emitter configuration. This feature causes an additional reverse biased diode between emitter and collector, which does not effect normal operation.

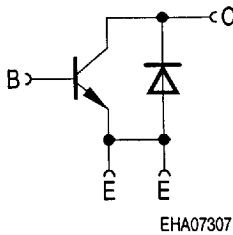

Transistor Schematic Diagram

The common emitter configuration shows the following advantages:

- Higher gain because of lower emitter inductance.
- Power is dissipated via the grounded emitter leads, because the chip is mounted on copper emitter leadframe.

Please note, that the broadest lead is the emitter lead.

The AC characteristics are verified by random sampling.

Total power dissipation $P_{tot} = f(T_A^*, T_S)$

* Package mounted on epoxy

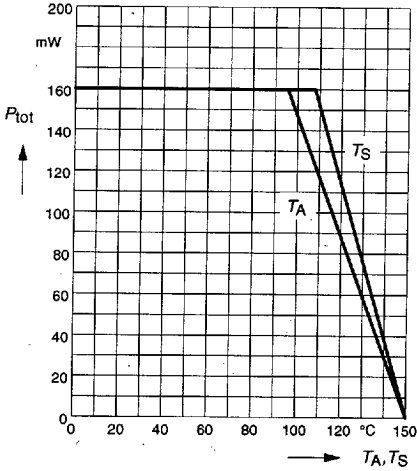

Transition frequency $f_T = f(I_C)$

$f = 2$ GHz

$V_{CE} =$ parameter in V

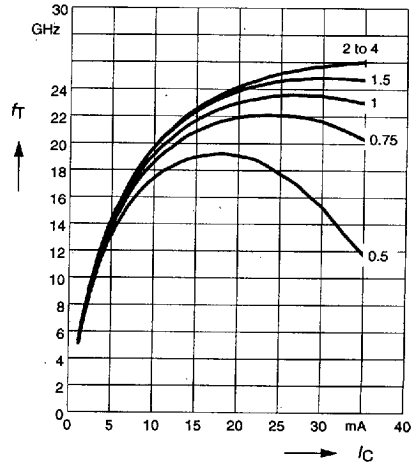

Permissible Pulse Load $R_{thJS} = f(t_p)$

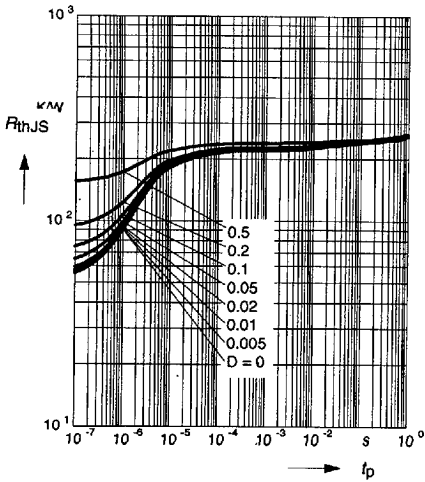

Permissible Pulse Load

$$P_{totmax}/P_{totDC} = f(t_p)$$

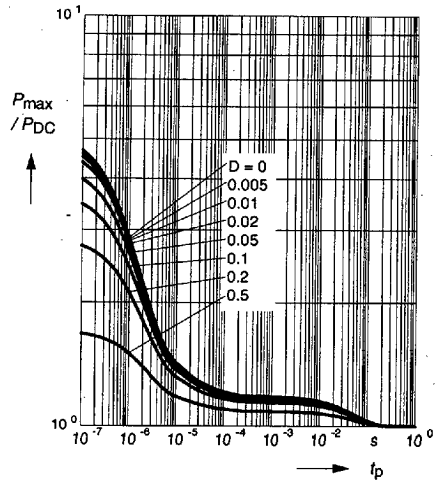

Power gain $G_{ma}, G_{ms}, |S_{21}|^2 = f(f)$

$V_{CE} = 2V, I_C = 20\text{ mA}$

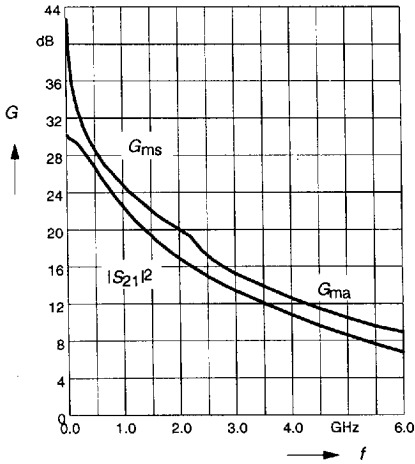

Power gain $G_{ma}, G_{ms} = f(I_C)$

$V_{CE} = 2V$

$f = \text{parameter in GHz}$

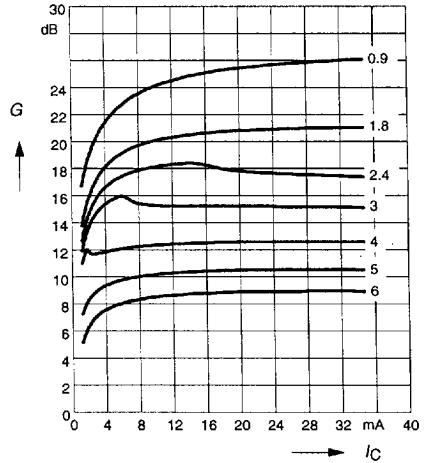

Power gain $G_{ma}, G_{ms} = f(V_{CE})$

$I_C = 20\text{ mA}$

$f = \text{parameter in GHz}$

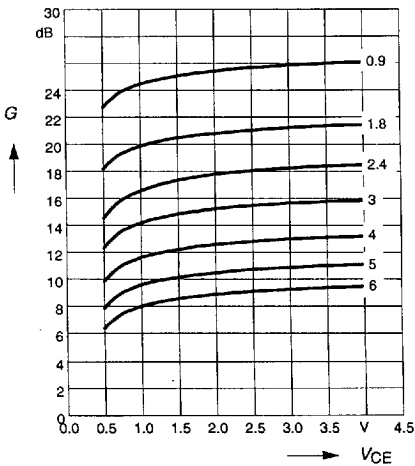

Collector-base capacitance $C_{cb} = f(V_{CB})$

$V_{BE} = 0, f = 1\text{ MHz}$

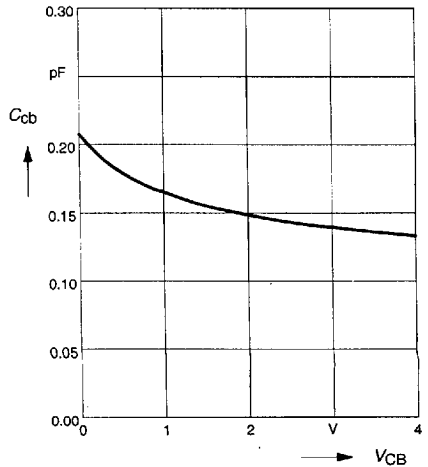

Noise figure $F = f(I_C)$

$V_{CE} = 2\text{ V}$, $Z_S = Z_{Sopt}$

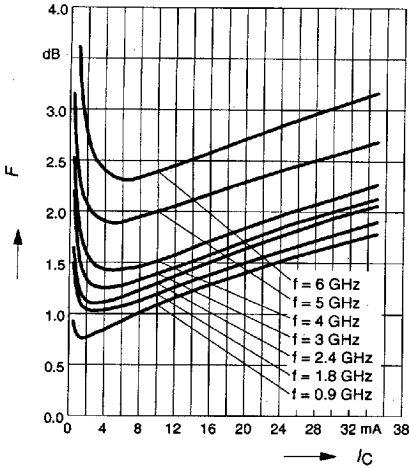

Noise figure $F = f(I_C)$

$V_{CE} = 2\text{ V}$, $f = 1.8\text{ GHz}$

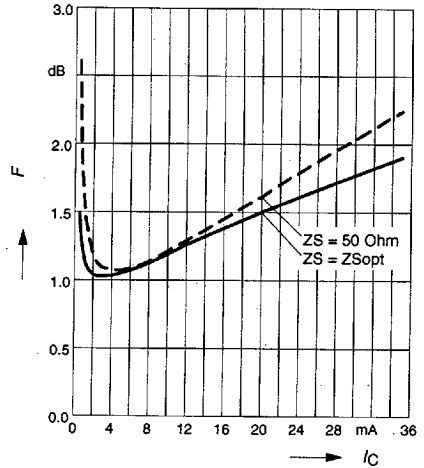

Noise figure $F = f(f)$

$V_{CE} = 2\text{ V}$, $Z_S = Z_{Sopt}$

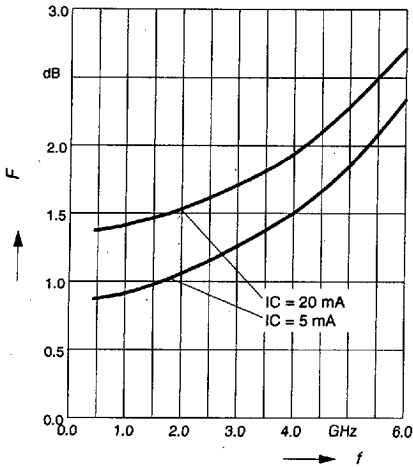

Source impedance for min.

Noise Figure versus Frequency

$V_{CE} = 2\text{ V}$, $I_C = 5\text{ mA} / 20\text{ mA}$

